



Model 100 T-Stat LLC User's Manual



COPYRIGHT NOTICE

Copyright © 2018 by Quest Controls Inc. (QUEST).
The material discussed in this publication is the proprietary property of QUEST.
QUEST retains all rights to reproduction and distribution of this publication.
Specifications are subject to change without notice.



Table of Contents

AT&T “Ask Yourself” Principles and Philosophy 3

1.0 Overview 4

 1.2 Features and Benefits 4

2.0 Installation / Wiring 4

 2.1 Installing the mounting plate 5

 2.2 Wiring 5

3.0 Front Panel Display/Keypad Operation 7

 3.1 Run Mode 7

 3.2 Occupied Override 7

 3.3 Lead Switch 7

 3.4 T-Stat Settings 8

4.0 Care and Cleaning 8

5.0 Troubleshooting 9

Table of figures

Figure 1 – Back Plate Mounting 4

Figure 2 - Connection Descriptions 5

Figure 3 – Typical Wiring Diagram 6

AT&T “Ask Yourself” Principles and Philosophy

“*Ask Yourself*” principles are presented in the form of questions. Listed in the table below are the ten “*Ask Yourself*” questions that you should be able to confidently answer “yes” to before you undertake any task related to the network. If you are unable to answer “yes” to any of the ten questions, please stop and resolve the issues before resuming your work. Protecting the network is everyone’s responsibility.

THE TEN “ASK YOURSELF” PRINCIPLES:

1. Do I have the proper access and appropriate login credentials for the work I am about to do?
2. Do I know why I'm doing this work?
3. Have I identified and notified all key stakeholders who will be directly and possibly indirectly affected by this work?
4. Can I prevent or control service interruption or defect introduction?
5. Is this the right time to do this work?
6. Am I trained and qualified to do this work?
7. Is all relevant documentation for this work complete, current and error-free?
8. Do I have everything I need to quickly and safely restore service if something goes wrong?
9. Have I walked through the entire process or procedure I am about to follow?
10. Have I verified/validated that I have completed all the steps in the process or procedure, obtained proper closure and notified appropriate technology centers, as applicable?

1.0 Overview

The Quest Controls Lead/Lag control thermostat is designed for controlling two single stage HVAC systems. It is an easy to use thermostat for remote shelters that require a simple to use lead/lag controller with a wide profile operating range for cooling.

1.2 Features and Benefits

- Controls two single-stage HVAC systems for Fan, Cool and Heat.
- Powered from the HVAC 24VAC transformers.
- Automatic lead change every 24 hours.
- LCD display for current operating mode and shelter temperature readings.
- Comfort mode to allow “Occupied” settings for a one hour timed duration.
- Five button keypad for navigation to other status screens.
- Built in zone temperature.
- All configurations and setpoints are stored in non-volatile flash memory and are not field changeable.

2.0 Installation / Wiring

The T-Stat LLC is a simple application specific controller designed to control two Single -Stage Conventional HVAC systems.

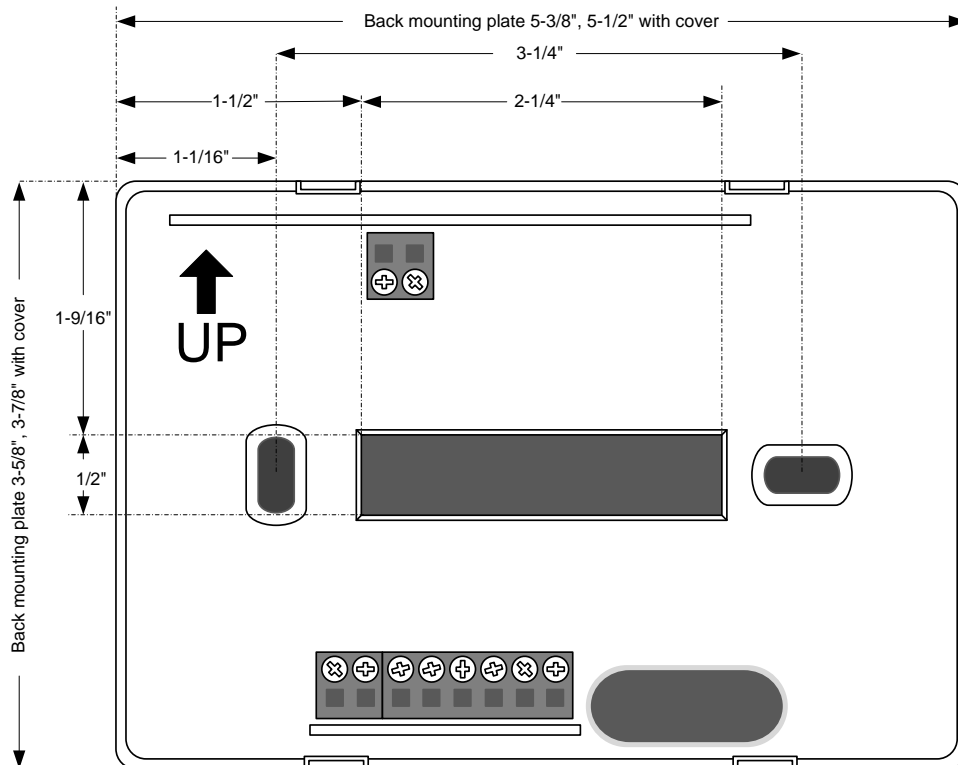

Figure 1 – Back Plate Mounting

2.1 Installing the mounting plate

1. **Plan the Location** –The T-Stat should be mounted away from external sources of heat or cold (doors, HVAC supply grill, exhaust from equipment, radio heads, etc.) and provide a good representation of the shelter’s temperature.
2. **Prepare the Area** - The mounting screw holes will line up on a standard duplex outlet box or can be flush mounted to the wall. When flush mounting, ensure clearance for the wires to exit through the center window on the back plate. Install outlet box or screw anchors and run thermostat wires.
3. **Remove the cover** - The cover of the T-Stat is held on by four clips, two on the top and two on the bottom. Remove the cover carefully, the cover may be snug and depressing the clips through the slot openings may help in getting the cover off.
4. **Mount the Plate** - Dress the wires through the center window on the back plate and install mounting screws. Tighten screws to ensure the plate is mounted securely, but do not over tighten and warp the back plate.

2.2 Wiring

1. **Terminate the Wire Connections** – Cut off excess wire, dress wire flush to the back panel and strip 1/4” of insulation to expose conductor. Insert and tighten using the Wire Terminations diagram. Label all point to point connections at both ends of the cable.
2. **Connection Descriptions:**

Terminal	Description – wire color
HVAC 1 - R	24VAC power - red
HVAC 1 - C	24VAC common - black
HVAC 1 - G	Fan Control – green
HVAC 1 - Y	Call for Cool - yellow
HVAC 1 - W	Call for Heat - white
HVAC 2 - R	24VAC power - red
HVAC 2 - C	24VAC common - black
HVAC 2 - G	Fan Control – green
HVAC 2 - Y	Call for Cool - yellow
HVAC 2 - W	Call for Heat - white

Figure 2 - Connection Descriptions

3. Typical Wiring Diagram

T-Stat Lead/Lag Controller

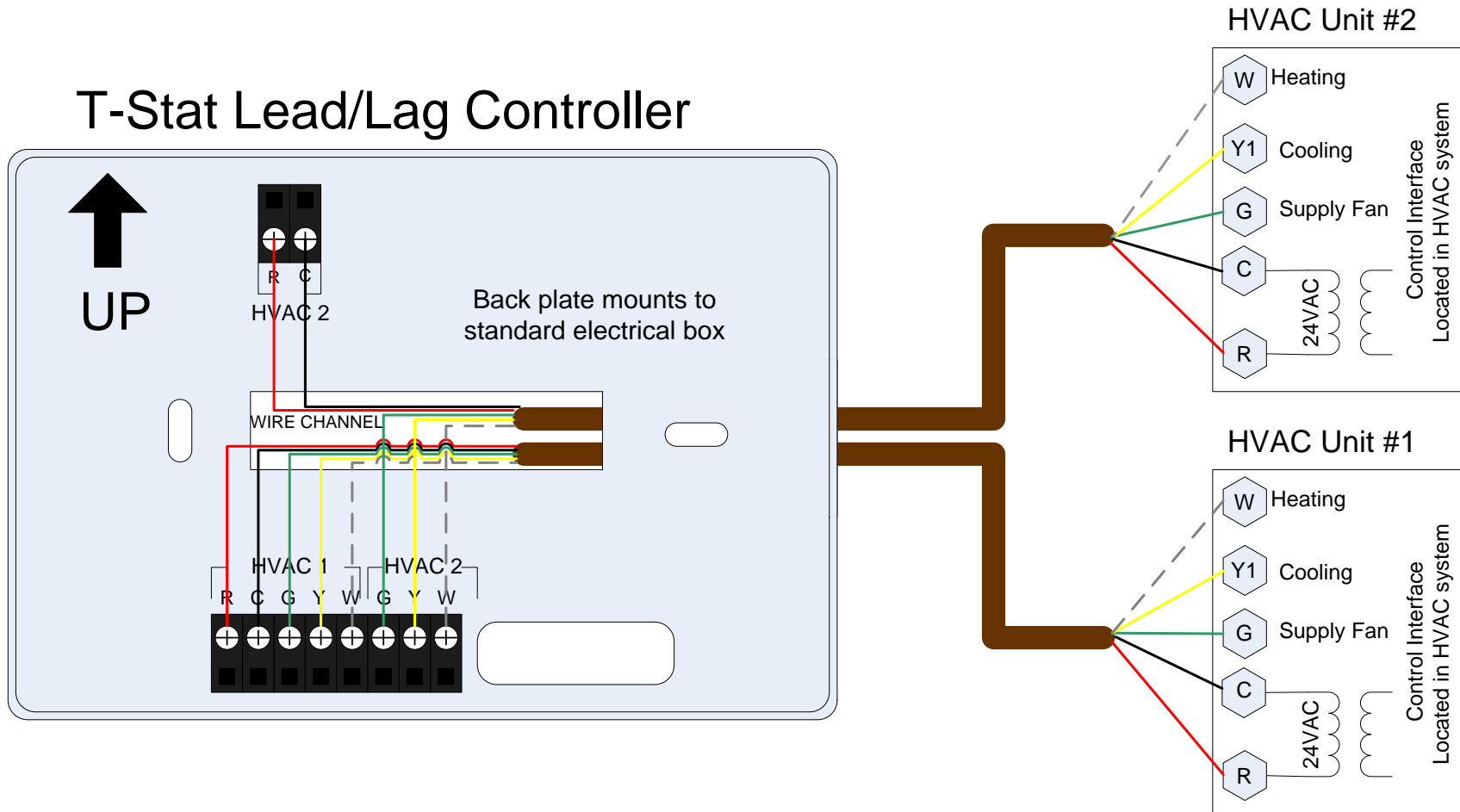

Figure 3 – Typical Wiring Diagram

3.0 Front Panel Display/Keypad Operation

The Quest T-Stat LLC has a 2X16 character backlit LCD display and five buttons for status review and programming. The backlit is normally off but will turn on with a press of any key. The backlight will turn off after a few seconds of no keys being pressed. The first press of the keypad will turn on the backlight and tell the T-Stat to be ready for additional key presses. All keypad operation described below is after you press and release any key to enable the backlight.

3.1 Run Mode

The display will show the current lead system along with the zone sensor reading on the top line. The second line will show the system status i.e. calling for cooling or heating along with the Lead fan status of ON or Auto. Additional status information can be reviewed by pressing the up or down arrow keys. This will cycle the display on the second line to show: Occupied status and control mode of each HVAC unit.

Lead Sys 1	80°F
Cool 1	Fan Auto

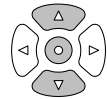

3.2 Occupied Override

Press the center button until the T-Stat asks if you want to enter occupied override mode. The default value is No. Use the up or down arrow to change the value to Yes. Then press the center button again to accept your choice. If you choose Yes then the T-Stat will be in occupied override mode for the programmed delay time or unless the user presses the center button again to disable the occupied override mode.

Enter Occupied?
No

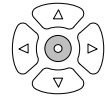

3.3 Lead Switch

The lead system will switch based upon an internal timer. The default setting is every 24hours. The Lead can be switched manually by pressing the up and down arrow simultaneously. The display will ask if you want to switch the lead with the default answer value of No. Press the up or down arrow to change the answer to Yes and then press the center button to do the change.

Make HVAC2 Lead?
No

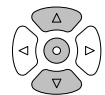

3.4 T-Stat Settings

The T-stat LLC comes preprogrammed from Quest and cannot be changed in the field. The settings are as follows:

Setpoint Name	Value
Normal mode - Lead unit cooling on	80
Normal mode - Lag unit cooling on	84
Normal mode - All cooling off	75
Normal mode - Lead unit heating on	45
Normal mode - Lag unit heating on	43
Normal mode - All heating off	50
Comfort mode - Lead unit cooling on	76
Comfort mode - Lag unit cooling on	80
Comfort mode - All cooling off	71
Comfort mode - Lead unit heating on	55
Comfort mode - Lag heating on	53
Comfort mode - All heating off	60
Lead Switch time	24 hours
Comfort mode time	1 hour
Lead unit fan operation	Automatic

4.0 Care and Cleaning

The T-Stat LLC should provide years of uninterrupted service. Minimal preventive maintenance is required. However; it is important to make sure that the T-Stat is kept free of dust. A dusty T-Stat will not allow air to circulate properly around the built-in temperature sensor effecting proper operation of the unit.

Ensure temperature probe in this air tunnel is free of dirt and dust.

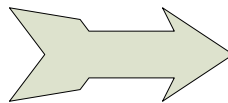

5.0 Troubleshooting

LCD Screen is dark and no characters are displayed	Remove cover and verify presence of power on the “R” terminal, check connection of the common on the “C” terminal. Check for presence of 24VAC between R and C.
T-Stat mode say Cool1, but compressor does not engage	Verify connection to HVAC unit. Ensure short-cycle timer is not inhibiting unit.
Buttons do not respond	Press buttons slowly, some functions may take pressing the button twice.
Display is corrupted	<p>First, cycle power to the unit. If this does not correct the problem, reset system by removing the T-Stat body from the mounting plate. Then return the body to the mounting plate while depressing the up arrow, center button and down arrow all at the same time. The display will respond with “Cold Sense”, these buttons must be held for a minimum 5 second. This will begin a system restart and the display will respond with “Cold Start”. Release the buttons at this time. This action will reset the T-Stat and return all settings to their factory defaults.</p> <div style="display: flex; align-items: center; gap: 10px;"> <div style="border: 1px solid black; padding: 2px 10px;">Cold Start</div>  </div>

Contact Information:

Web Site

www.questcontrols.com

Quest Controls, Inc.

Tel: (941) 729-4799, Fax: (941) 729-5480
208 9th Street Dr. West, Palmetto FL 34221

Technical & Applications Support:

CustomerService@QuestControls.com

(941) 729-4799 Option 5

RMA Support:

(941) 723-4112